

**Mariner**  
**QM483441MTL**  
**DOUBLE TOWEL RAIL 24"**

**Metlex**

PROFESSIONAL BATHROOM AND  
WASHROOM ACCESSORIES



**MATERIAL**

Stainless Steel & Diecast Construct

**FINISH / COLOUR**

Chrome Plated

**FREQUENTLY USED APPLICATIONS**

Commercial Washrooms  
Hotels  
Domestic Dwellings  
Care Homes

**FEATURES**

Fixed Bracket Centres.  
Fits Most Existing Screw Holes.  
All Fixings Supplied.

**PERFORMANCE STANDARDS**

Meets Performance Requirements Of Service  
Condition 2.  
BS EN ISO 9221:2017 - Corrosion Resistant  
(NSS 48hr Salt Spray, Min. Grade9)

**CARE AND MAINTENANCE**

Clean Surfaces With A Damp Cloth and Wipe Dry  
Using A Soft Cloth.  
Do Not Use Chemical or Abrasive Cleaners As  
These May Damage The Surface Finish.

**GUARANTEE**

Consumer Statutory Rights Apply.  
12 Year Manufacturing Guarantee.

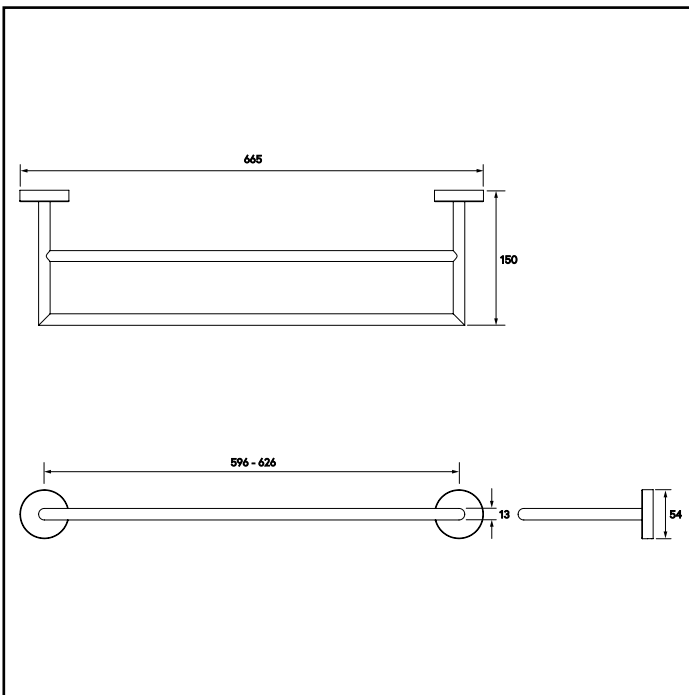

**UNIQUE X PLATE SYSTEM**

Fits most existing screw holes.  
Max screw hole centres are 34mm.

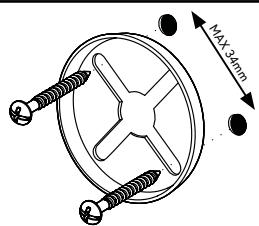

Printed material, designs and packaging are protected by copyright and design rights.