

Mariner
QM483241MTL
SINGLE TOWEL RAIL 18"

Metlex

PROFESSIONAL BATHROOM AND
WASHROOM ACCESSORIES



MATERIAL

Stainless Steel & Diecast Construct

FINISH / COLOUR

Chrome Plated

FREQUENTLY USED APPLICATIONS

Commercial Washrooms
Hotels
Domestic Dwellings
Care Homes

FEATURES

Fixed Bracket Centres.
Fits Most Existing Screw Holes.
All Fixings Supplied.

PERFORMANCE STANDARDS

Meets Performance Requirements Of Service
Condition 2.
BS EN ISO 9221:2017 - Corrosion Resistant
(NSS 48hr Salt Spray, Min. Grade9)

CARE AND MAINTENANCE

Clean Surfaces With A Damp Cloth and Wipe Dry
Using A Soft Cloth.
Do Not Use Chemical or Abrasive Cleaners As
These May Damage The Surface Finish.

GUARANTEE

Consumer Statutory Rights Apply.
12 Year Manufacturing Guarantee.

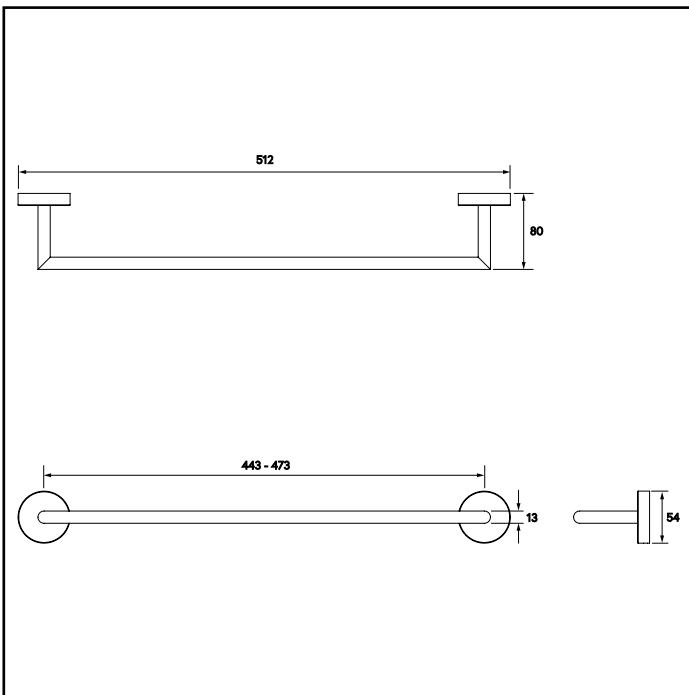

UNIQUE X PLATE SYSTEM

Fits most existing screw holes.
Max screw hole centres are 34mm.

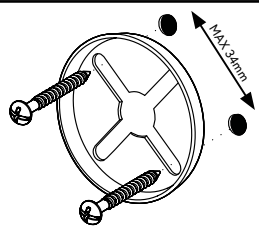

Printed material, designs and packaging are protected by copyright and design rights.